

# Technical Data Sheet

# ROPER RHODES®

## PURSUIT 1200mm Wall Mounted Unit

Whats in the box: 1x PUR1200X + Fixings

\*Reference basin TDS for further info

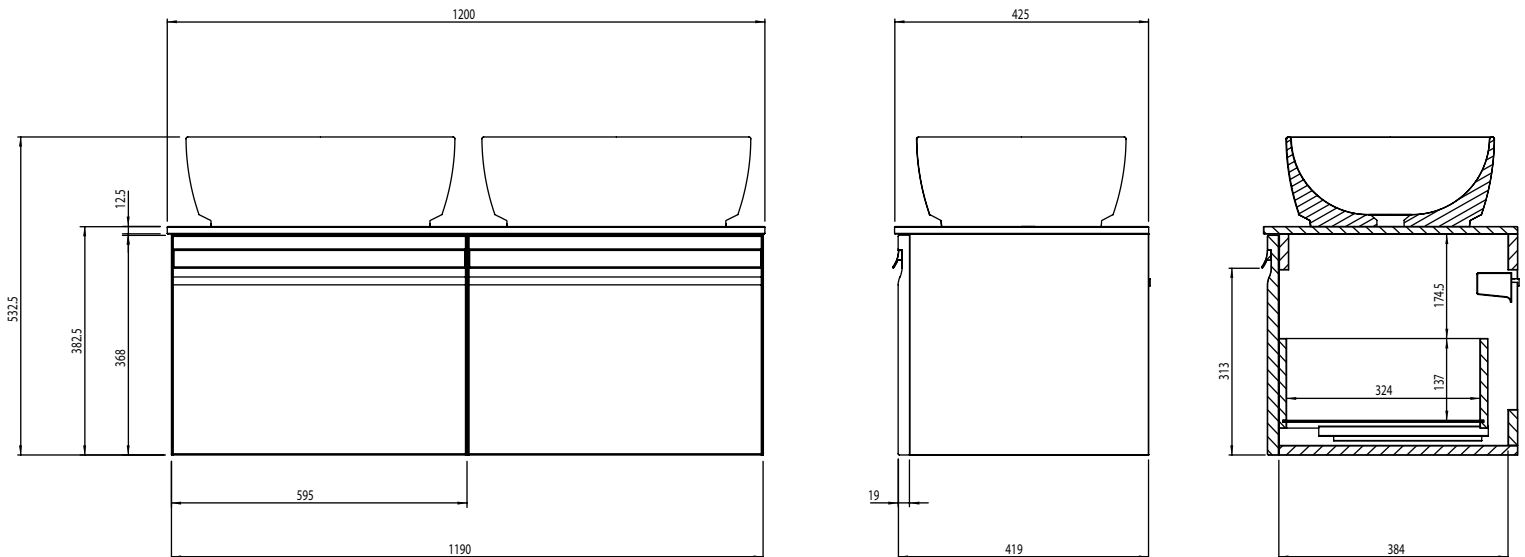

Diagrams not to scale  
All dimensions in mm  
tolerance of +/-5mm

### Materials

Carcass: 16mm Painted MDF & MFC

Fascia Components: 19mm Painted MDF or PVC backed MDF (Charcoal & Elm Finish)

\*\*Dimensions are subject to change, customers are advised to measure actual product before commencing installation.

\*\*\*Fixing point dimensions are for guidance only/the positions of wall fixing must be checked when product is received.

### Extra Dimensions

Internal Drawer Depth - Front to Back:

324mm

Internal Drawer Height:

137mm

Internal Drawer Width:

820mm

Hanger Centres:

24mm from side panel

### FAQs

Q: How big is the plumbing void?

A: 55mm

Q: How far apart are the hole centres for the handles?

A: 320mm (comes with pilot holes)

Q: Are the handles fitted?

A: Yes, handle comes pre-fitted and is removable.

Q: Are the runners soft close?

A: The runners are both soft close and quick release.

Q: How deep is the unit when the drawers are fully open?

A: Approx. 750mm including handle.

Q: Can the drawers be adjusted?

A: The drawers can be adjusted as detailed in the supplied instructions.

Q: What is the interior finish of the unit?

A: Dark Grey.

NOTE: Colours unique to Roper Rhodes - No RAL Code available