

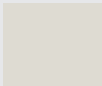

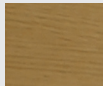

No.	Description	Code	Fixings Included
1	Hampton 600mm Semi-Countertop Unit	HAM600SCT.XX	Yes
2	Geo Semi Countertop Basin	G3SCBAS	Yes



Finishes Available	
	
Vanilla	Natural Oak
	
Mocha	Pewter
	
Chalk White	Slate Grey

Dimensions

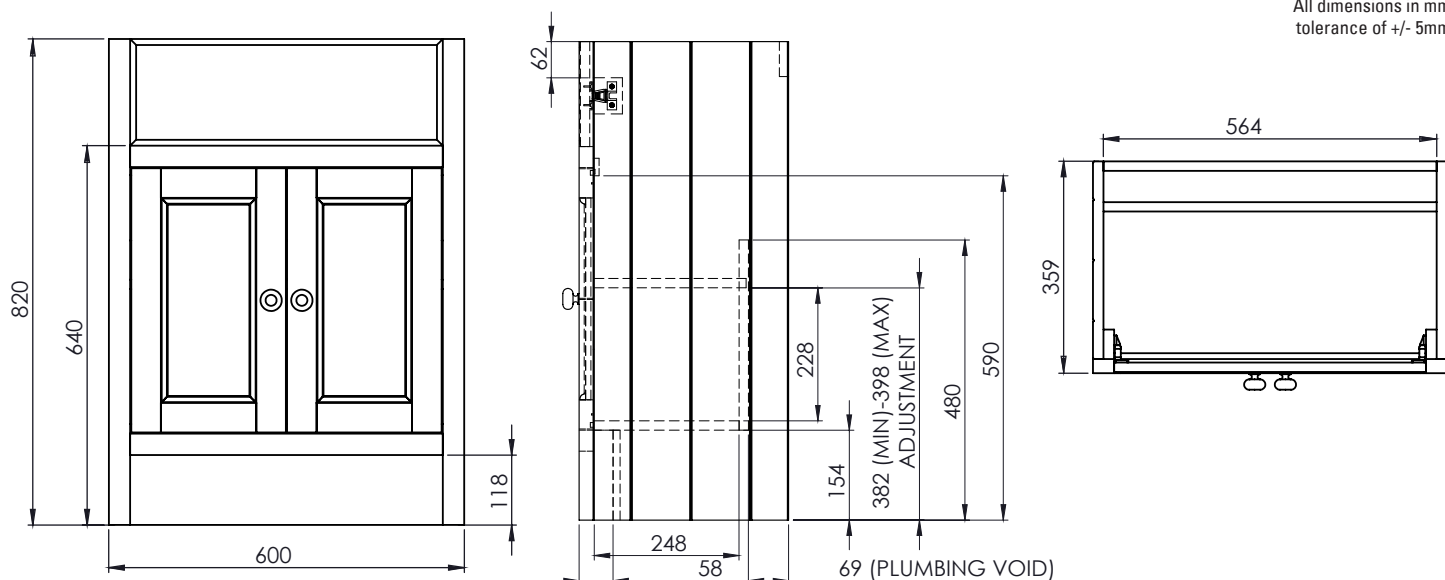

FAQ's

What is the depth of the unit with the door open? **630mm**

What is the width of the unit with the door open? **1040mm**

What is the gap between the wall and the back of the basin? **45mm**

How deep are the shelves? **260mm**





Can I use different handles? **The unit is supplied with a pilot hole for the standard handle, but others can be drilled by the fitter.**

What Semi-countertop basins can be used with this unit? **Any Roper Rhodes basins that fit standard depth worktops can be used.**

Can I repair small areas of damage? **Yes, we can supply small touch up paint pens for small paint repairs.**

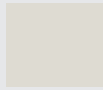
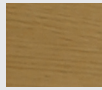
No.	Description	Code	Fixings Included
1	Hampton 550mm Countertop Unit	HAM600SCT.XX	Yes
2	Hampton 560mm Countertop Basin	HAM560C	N/A

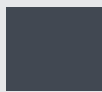

Finishes Available	
	
Vanilla	Natural Oak
	
Mocha	Pewter
	
Chalk White	Slate Grey

Dimensions

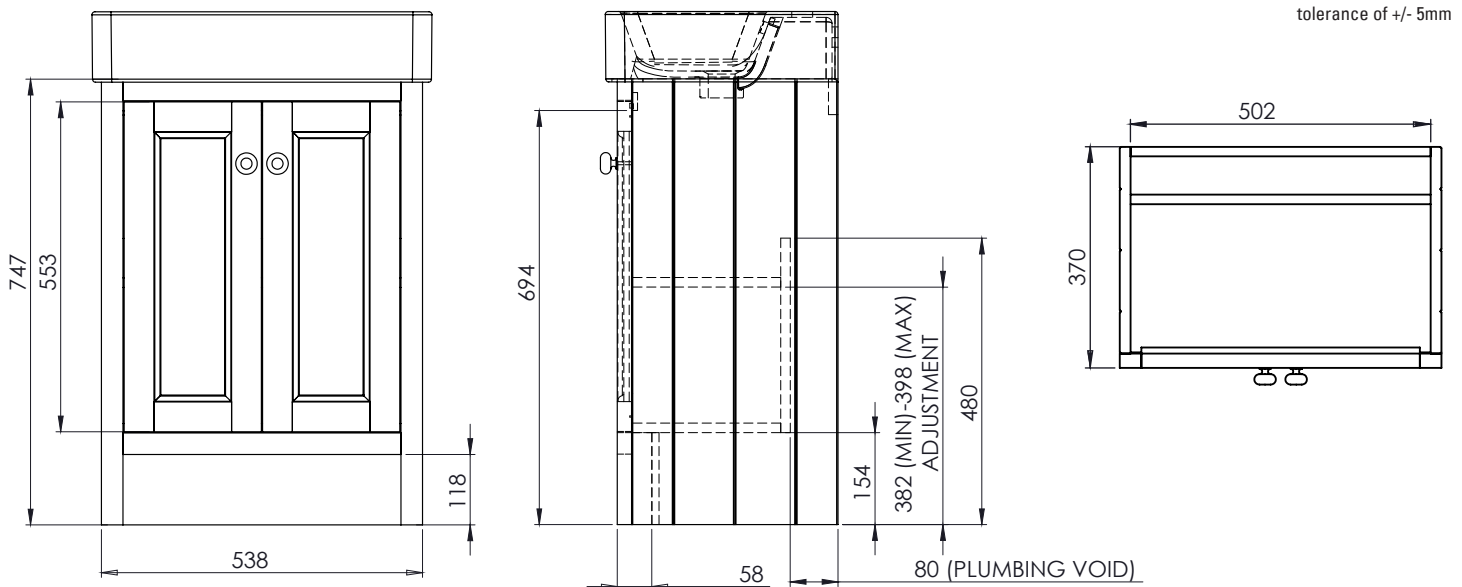

FAQ's

What is the depth of the unit with the door open? **590mm**

What is the width of the unit with the door open? **895mm**





How deep are the shelves? **250mm**

Can I repair small areas of damage? **Yes, we can supply small touch up paint pens for small paint repairs.**

How is the unit secured in place? **The unit can be secured to the wall through the upper brace at the rear of the unit. Fixings not supplied.**

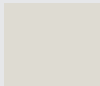
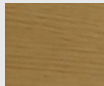
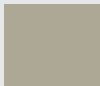
No.	Description	Code	Fixings
1	Hampton 700mm Basin Unit	HAM700B	Yes
2	Hampton 710mm Countertop Basin	HAM700C	N/A



Finishes Available	
	
Vanilla	Natural Oak
	
Mocha	Pewter
	
Chalk White	Slate Grey

Dimensions

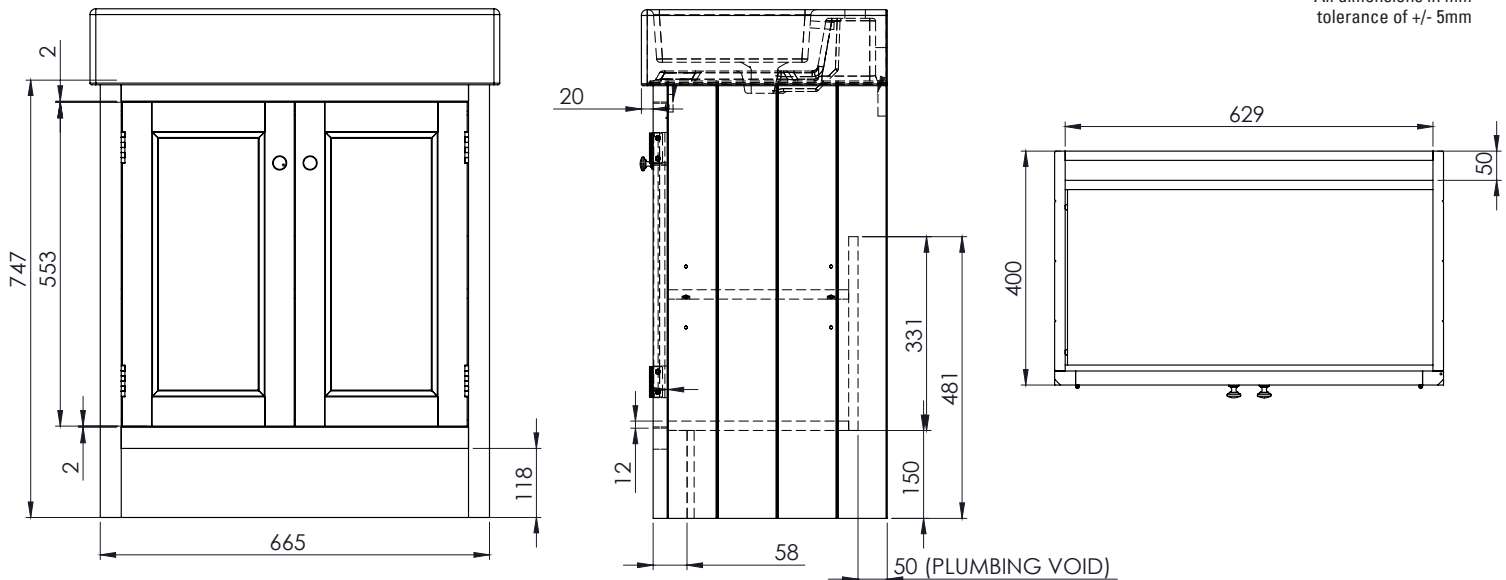





FAQ's

Can I repair small areas of damage? **Yes, we can supply small touch up paint pens for small paint repairs.**

How is the unit secured in place? **The unit can be secured to the wall through the upper brace at the rear of the unit. Fixings not supplied.**

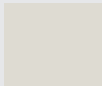
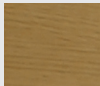
No.	Description	Code	Fixings
1	Hampton 450mm Cloakroom Unit	HAM450B	Yes
2	Hampton Cloakroom Basin	HAM450C	N/A

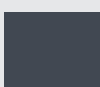

Finishes Available	
	
Vanilla	Natural Oak
	
Mocha	Pewter
	
Chalk White	Slate Grey

Dimensions

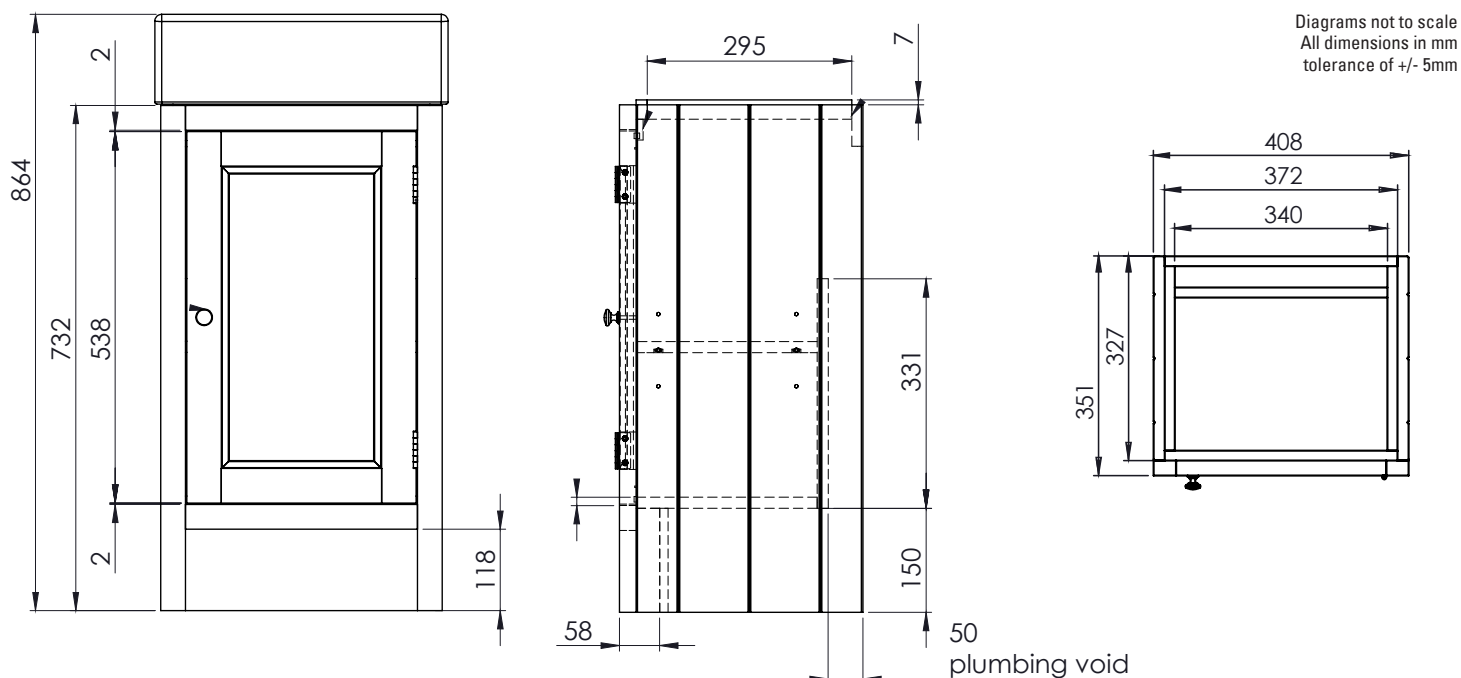

FAQ's

What is the depth of the unit with the door open? **690mm**

What is the width of the unit with the door open? **700mm**





Can the door be hung from either side? **Yes, pilot holes are made in the frame so that the hinge can be positioned on either side.**

Can I use different handles? **The unit is supplied with a pilot hole for the standard handle, but others can be drilled by the fitter.**

Can I repair small areas of damage? **Yes, we can supply small touch up paint pens for small paint repairs.**

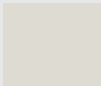
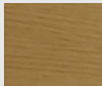
No.	Description	Code	Fixings
1	Hampton 600mm Back To Wall Unit	HAM600BTW	Yes



Finishes Available	
	
Vanilla	Natural Oak
	
Mocha	Pewter
	
Chalk White	Slate Grey

Dimensions

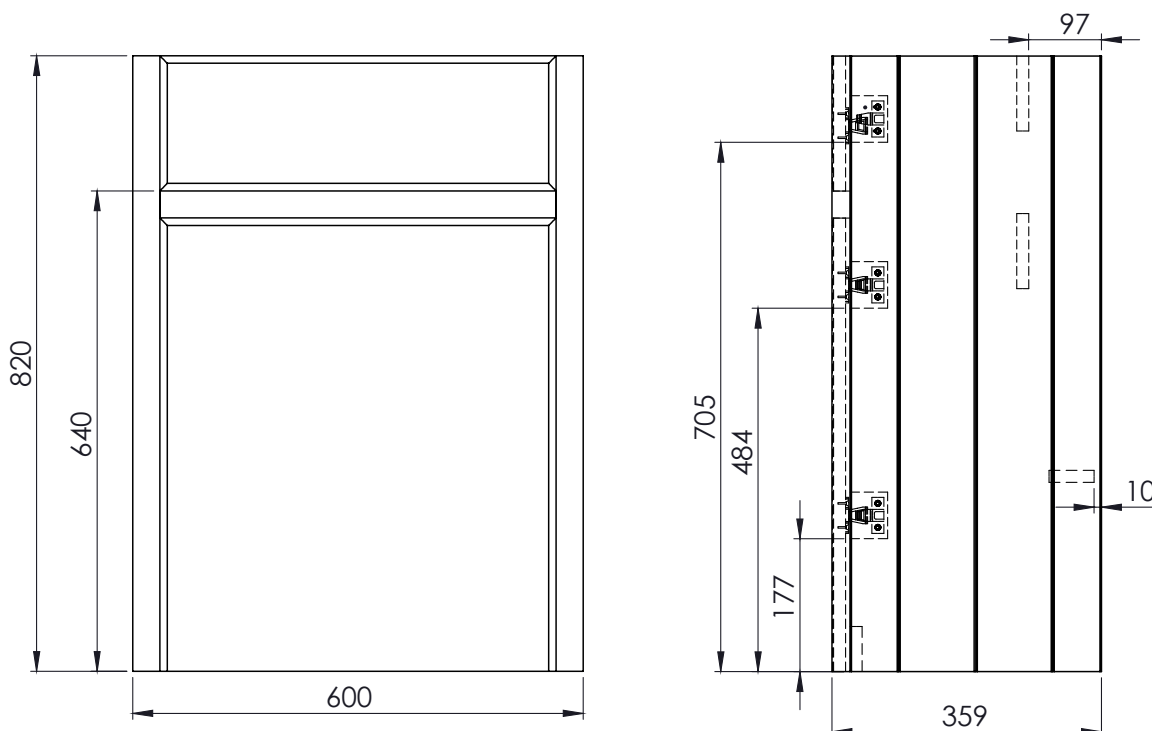

Diagrams not to scale
All dimensions in mm
tolerance of +/- 5mm

FAQ's

Does the unit come supplied with a worktop? **No, one should be chosen from our selection of worktops. A wider selection is available from our fitted furniture standard depth worktop options.**

Can a wall hung pan frame be used inside this unit? **Yes, the standard Roper Rhodes Wall Hung Frame can be used inside this unit if needed.**





Can a comfort height pan be used with this unit? **Yes - providing a comfort height cistern is used.**

Which cistern should I use with this unit? **All Roper Rhodes cisterns are compatible with this unit, but they should be checked for suitability with the desired pan.**

Do the fascias come pre-cut? **No, suitable holes for the pan and cistern buttons should be cut by the fitters. Any cuts or holes should be re-sealed to prevent any moisture ingress.**

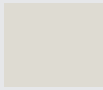
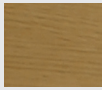
No.	Description	Code	Fixings Included
1	Hampton 600mm Underslung Basin Unit	HAM600US	Yes
2	Hampton 600mm Underslung Worktop	HAM4W6AUS	N/A
3	Hampton 600mm Underslung Basin	HAMUSC1	Yes



Finishes Available	
	
Vanilla	Natural Oak
	
Mocha	Pewter
	
Chalk White	Slate Grey

Dimensions

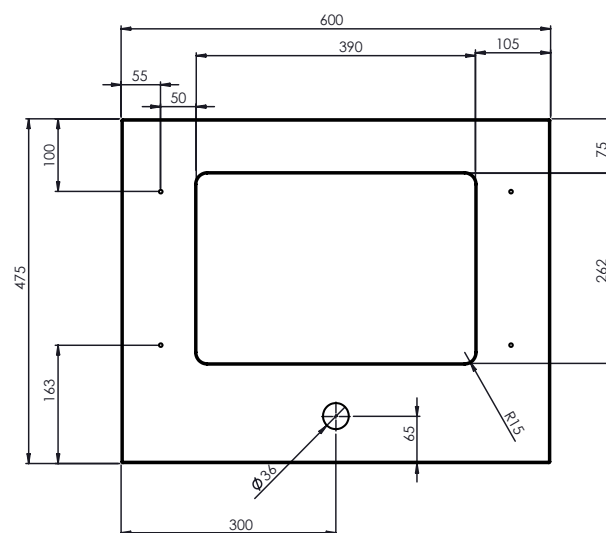
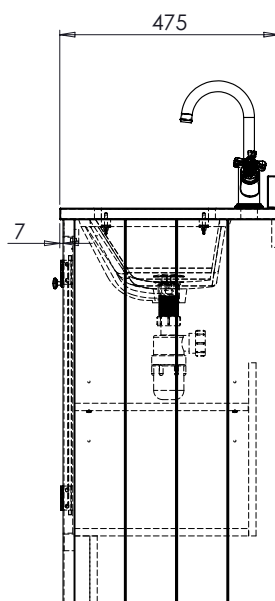
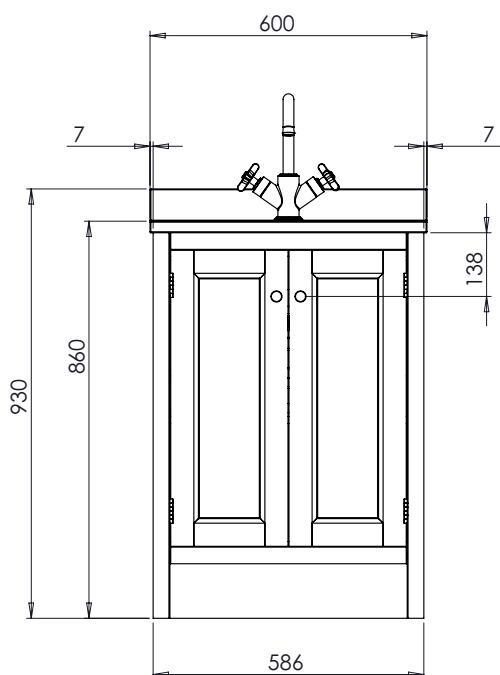

Diagrams not to scale
All dimensions in mm
tolerance of +/- 5mm

FAQ's

What is the depth of the units with the door open? **740mm**

What is the width of the unit with the doors open? **1600mm**

Are the shelves adjustable? **There are a number of shelf positioning holes drilled into the unit side panels.**

How deep is the basin water level? **The bowl will fill 120mm from the waste to the overflow.**

How tall is the worktop upstand? How thick is the worktop? **Upstand: 70mm Worktop Thickness: 25mm**

Is the underslung basin glazed on the underside? **No.**

Can I use other basins with the worktop? **No, the worktop is pre-cut to suit the Hampton Underslung Basin in size.**

Is the basin pre-fixed to the worktop? **No, they are supplied separately. Fixing brackets are supplied with the worktops to hold the basin in place.**

Can I repair small areas of damage? **Yes, we can supply small touch up paint pens for small paint repairs.**

How is the unit secured in place? **The unit can be secured to the wall through the upper brace at the rear of the unit. Fixings not supplied.**

No.	Description	Code	Fixings Included
1	Hampton 1200mm Underslung Worktop	HAM4W12AUS	N/A



Note:
Two 600mm Underslung Basin Units can be joined together to create a 1200mm wide double unit. In this configuration, a 1200mm worktop can be used with two underslung basins.

Dimensions

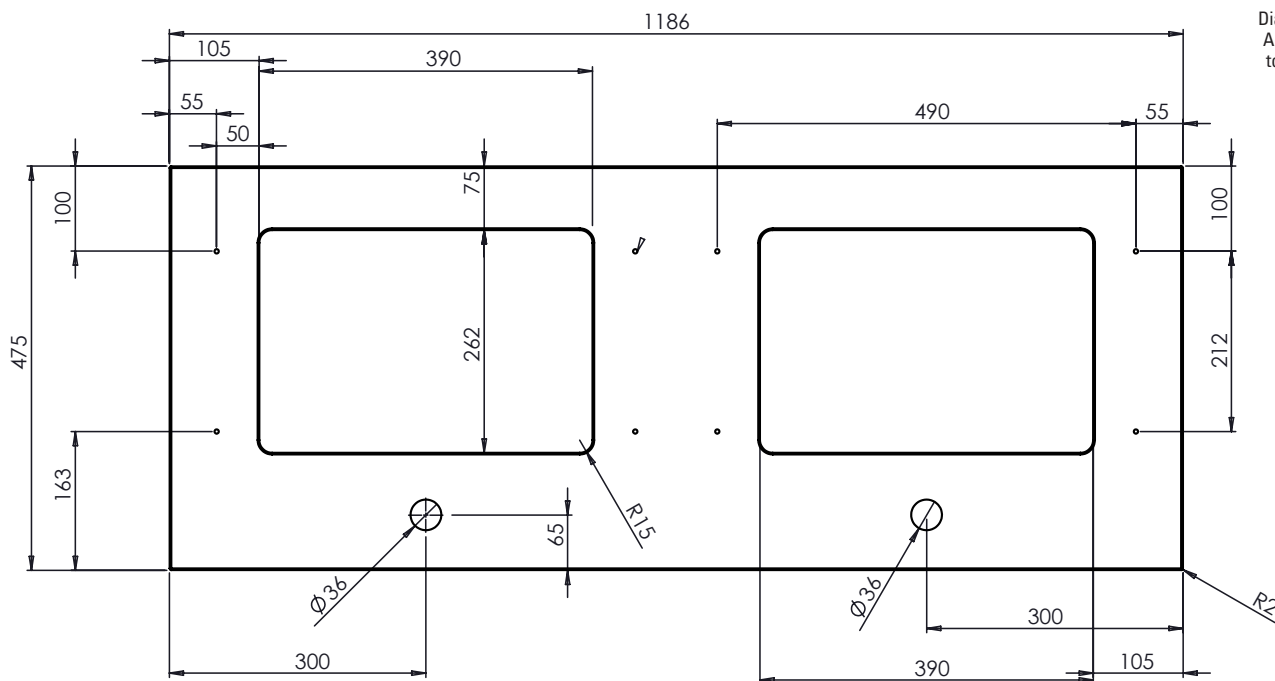







FAQ's

What is the overall depth of the units with the door open? **740mm**
What is the overall width of the units with the doors open? **1600mm**

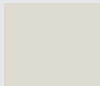
Note: See previous sheet for questions about the individual units.

1	Hampton Wall Mounted Basin Unit	HAM700WM	Yes
2	Hampton 710mm Countertop Basin	HAM700C	N/A



Finishes Available	
	
Vanilla	Natural Oak
	
Mocha	Pewter
	
Chalk White	Slate Grey

Dimensions

Diagrams not to scale
All dimensions in mm
tolerance of +/- 5mm

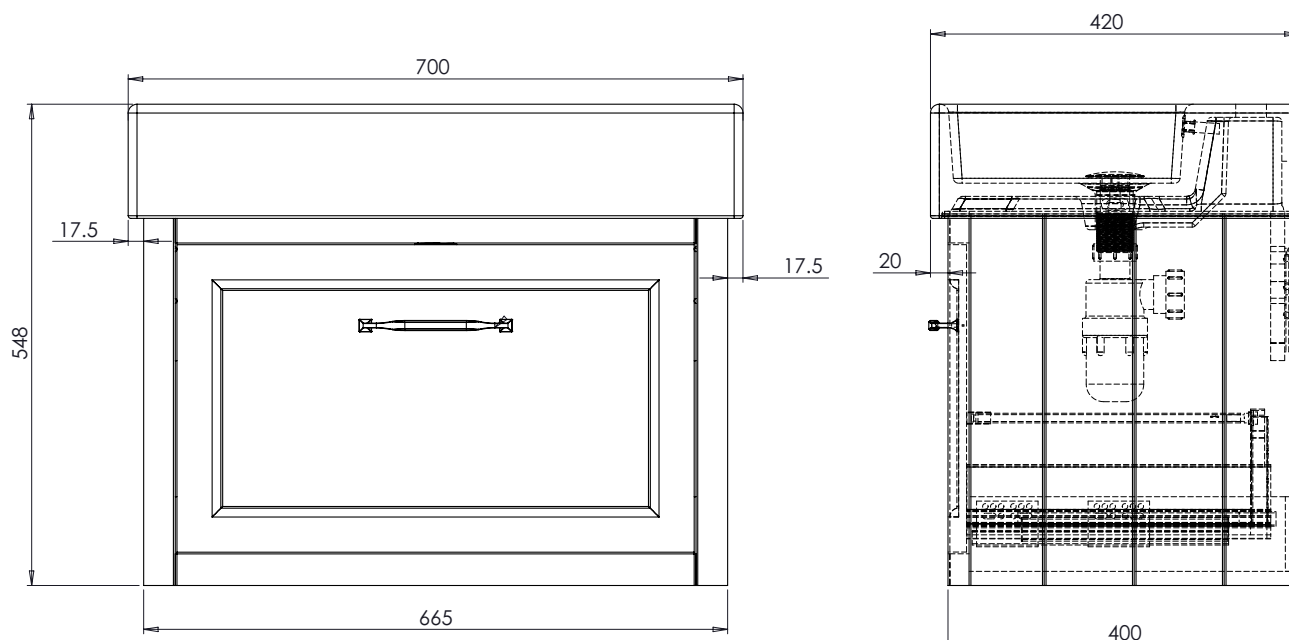

FAQ's

What is the depth of the units with the drawer open? **680mm**

What is the depth of the drawer open? **120mm**

What colour is the inside of the drawer? **The inside of the drawer box is colour matched to the unit.**





Can the drawer box be removed? **Yes, instructions on how to do so are included with the unit.**

Can I repair small areas of damage? **Yes, we can supply small touch up paint pens for small paint repairs.**

How is the unit secured in place? **The unit is secured to the wall with adjustable wall brackets.**

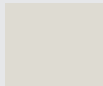
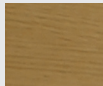
No.	Description	Code	Fixings
1	Hampton 400mm Floor Cupboard Unit	HAM400FC	Yes



Finishes Available	
	
Vanilla	Natural Oak
	
Mocha	Pewter
	
Chalk White	Slate Grey

Dimensions

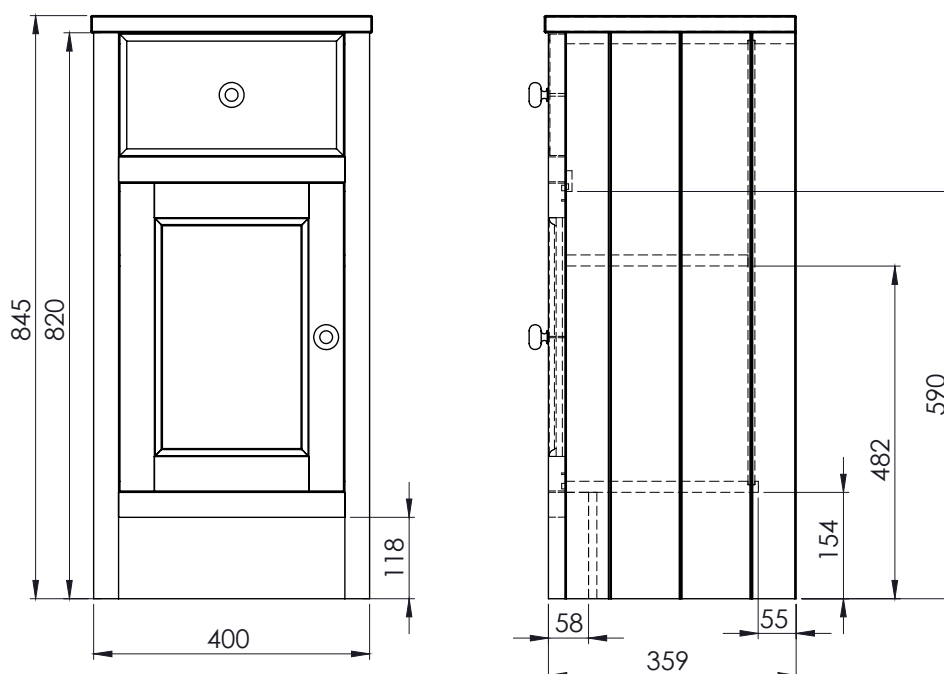

Diagrams not to scale
All dimensions in mm
tolerance of +/- 5mm

FAQ's

What is the depth of the unit with the door open? **685mm**

What is the depth of the unit with the drawer fully extended? **640mm**

What is the width of the unit with the door fully open? **680mm**

How deep are the shelves? **270mm**





Can the door be hung from either side? **Yes, pilot holes are made in the frame so that the hinge can be positioned on either side.**

Does the unit come with a worktop? **Yes, the cupboard comes with a colour matched worktop, but can be removed if the unit forms part of a run.**

Can I repair small areas of damage? **Yes, we can supply small touch up paint pens for small paint repairs.**

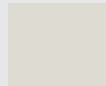
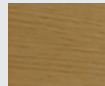
No.	Description	Code	Fixings Included
1	Hampton 420mm Mirror	HAM420M	Yes



Finishes Available	
	
Vanilla	Natural Oak
	
Mocha	Pewter
	
Chalk White	Slate Grey

Dimensions

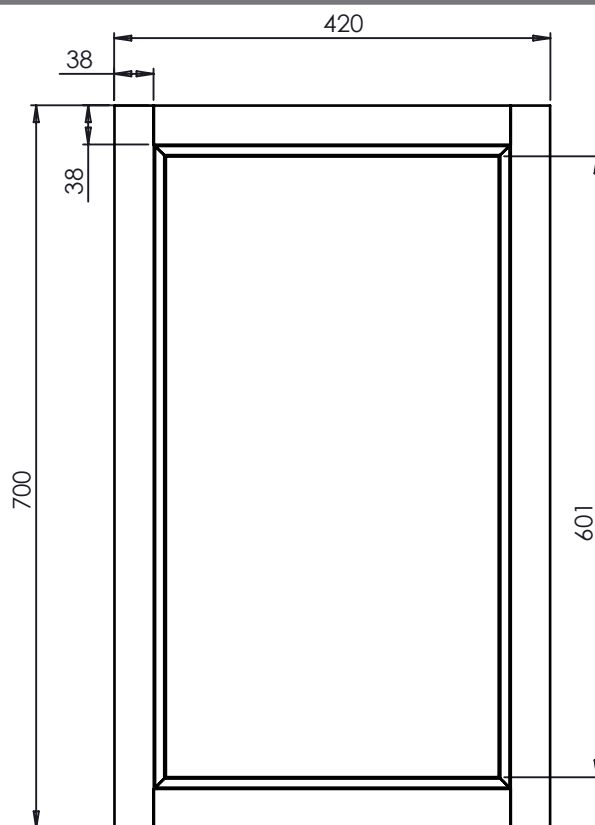





Diagrams not to scale
All dimensions in mm
tolerance of +/- 5mm

FAQ's

Can the mirror be hung portrait and landscape? **The mirror frame has fixing holes for both installations.**
Can I repair small areas of damage? **Yes, we can supply small touch up paint pens for small paint repairs.**

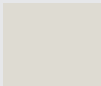
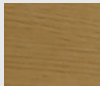
No.	Description	Code	Fixings
1	Hampton 570mm Mirror	HAM600M	Yes



Finishes Available	
	
Vanilla	Natural Oak
	
Mocha	Pewter
	
Chalk White	Slate Grey

Dimensions

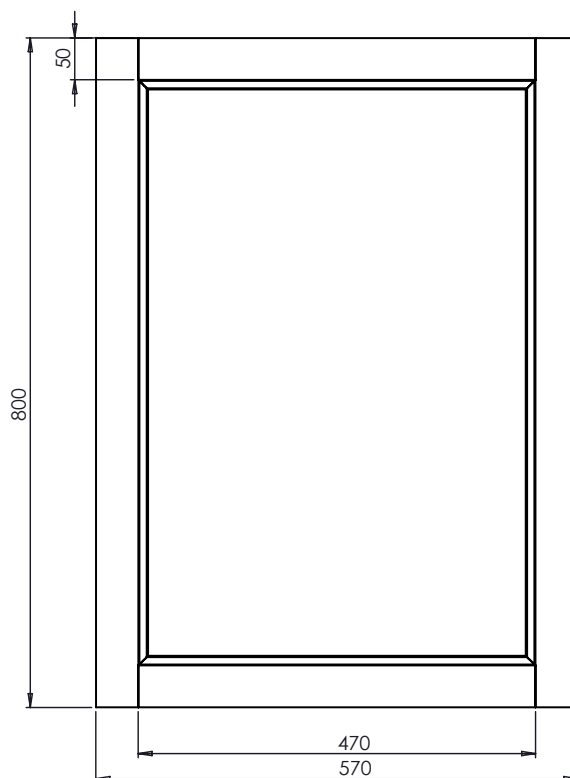

Diagrams not to scale
All dimensions in mm
tolerance of +/- 5mm





FAQ's

Can this mirror be hung in both portrait and landscape orientations? **Yes there are fixing holes for both options.**

How is this mirror hung on the wall? **The mirror has keyhole slots cut into the wooden frame. The portrait holes are approx. 235mm from the top edge of the frame. The landscape holes are approx. 165mm from the left hand edge of the frame.**

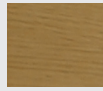
No.	Description	Code	Fixings
1	Hampton 700mm Basin Unit	HAM600SCT.XX	Yes



Finishes Available	
	
Vanilla	Natural Oak
	
Mocha	Pewter
	
Chalk White	Slate Grey

Dimensions

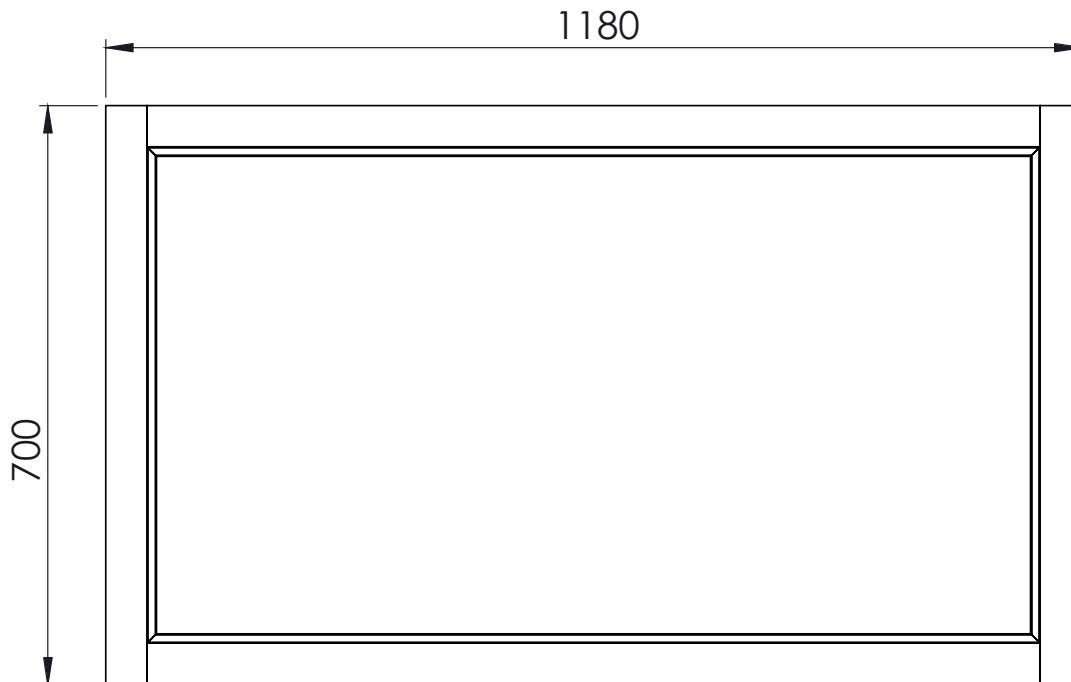

Diagrams not to scale
All dimensions in mm
tolerance of +/- 5mm

FAQ's





Question goes here? **Answer**

Question goes here? **Answer**

Question goes here? **Answer**

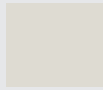
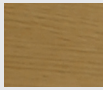
No.	Description	Code	Fixings
1	Hampton Illuminated Mirror Frame	HAM600SCT.XX	Yes
2	Hampton LED Illuminated Mirror	HAMILL6MIR	Yes

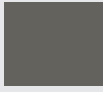

Finishes Available	
	
Vanilla	Natural Oak
	
Mocha	Pewter
	
Chalk White	Slate Grey

Dimensions

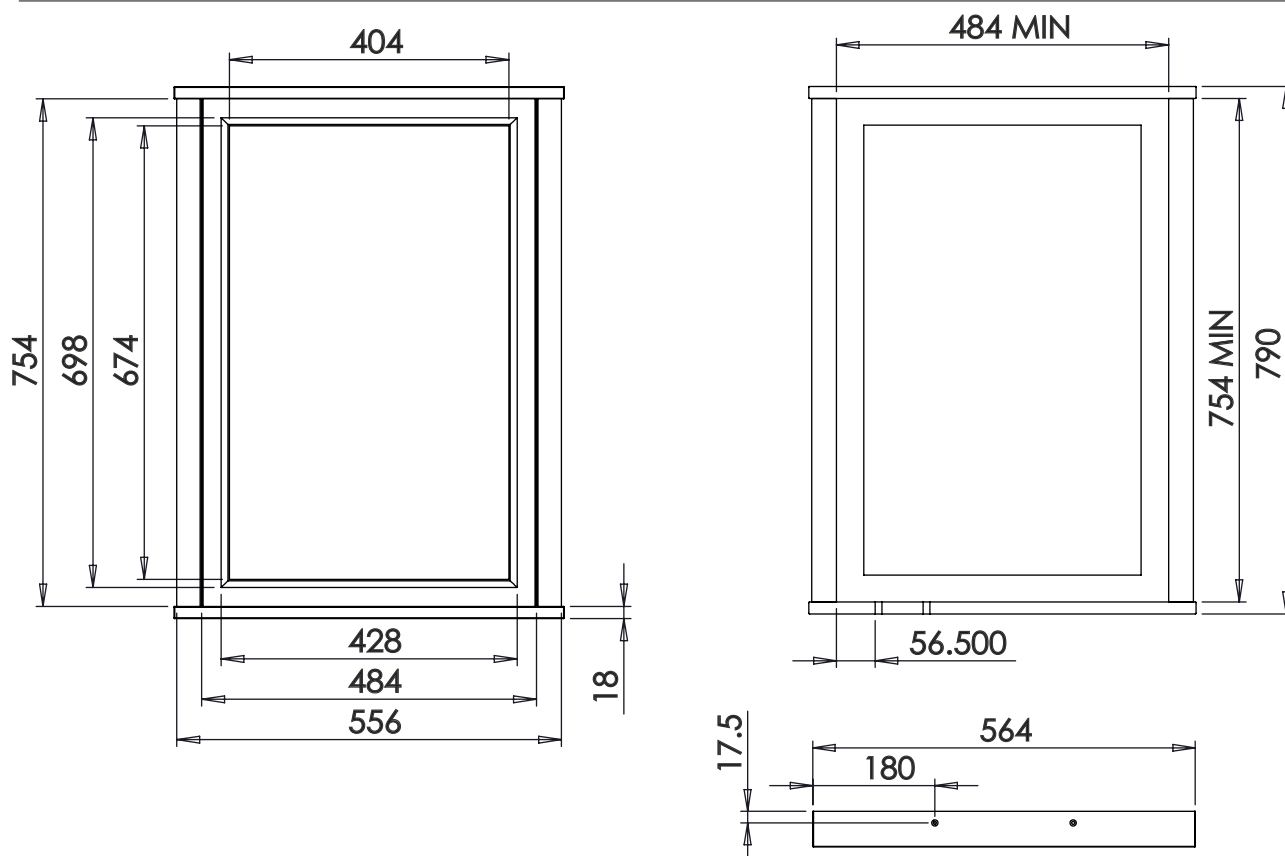

FAQ's

What is the total power consumption of the mirror? **35.5 watts**

What is the colour temperature of the LED lighting? **6000 kelvin**





What is the total amount of lumens produced by the LED lighting? **600 lumens**

Where is the mains cable located? **The mains cable is located in the centre of the back of the mirror.**

Can the mirror be hung separate of the mirror frame? **No, the keyhole slots are only present on the frame.**

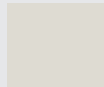
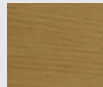
No.	Description	Code	Fixings
1	Hampton 565mm Cabinet	HAMCAB	Yes



Finishes Available	
	
Vanilla	Natural Oak
	
Mocha	Pewter
	
Chalk White	Slate Grey

Dimensions

Diagrams not to scale
All dimensions in mm
tolerance of +/- 5mm

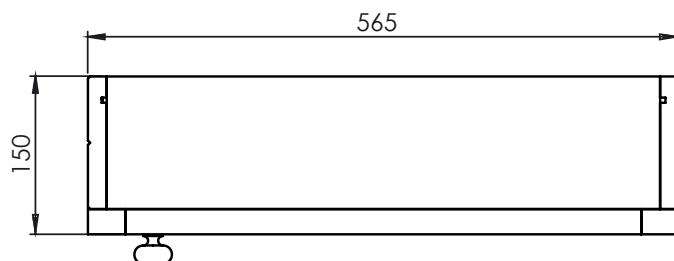
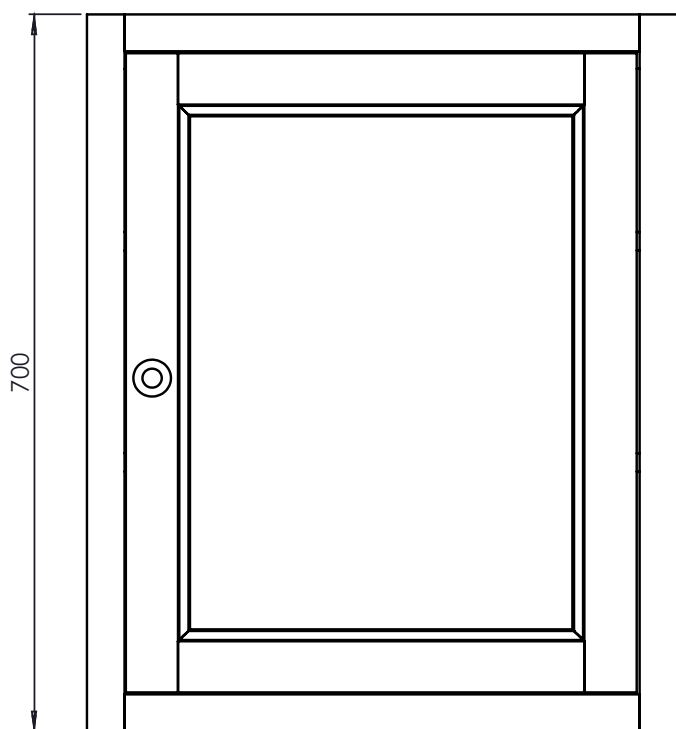

FAQ's

Is the door reversible? **No, the door can only be hinged on the right hand side.**

Are the shelves adjustable? **Yes, there are three shelf positions.**

Can I use different handles? **The unit is supplied with a pilot hole for the standard handle, but others can be drilled by the fitter.**

Can I repair small areas of damage? **Yes, we can supply small touch up paint pens for small paint repairs.**