

Technical Data Sheet

ROPER RHODES®

DIVERGE 800mm Floor Mounted Unit

Whats in the box: 1x DIV8FX

*Reference basin TDS for further info

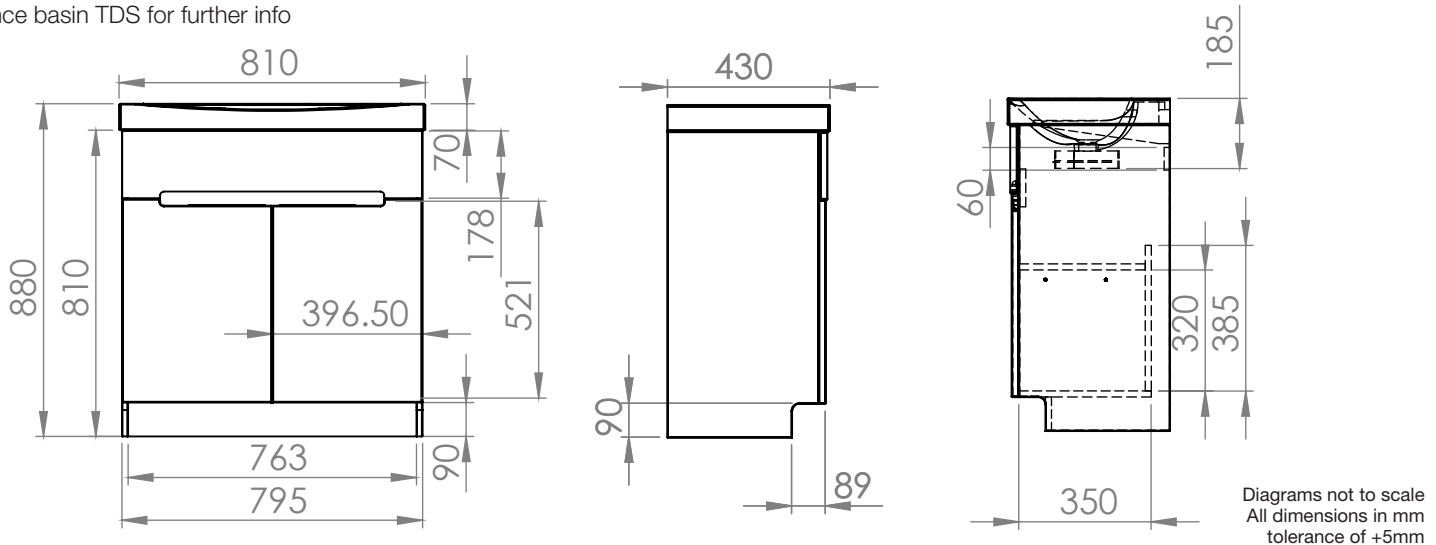

Materials

Carcass: MFC

Fascia Components: Painted or PVC Wrapped MFC

**Dimensions are subject to change, customers are advised to measure actual product before commencing installation.

***Fixing point dimensions are for guidance only/the positions of wall fixing must be checked when product is received.

Extra Dimensions

Internal Drawer Depth - Front to Back:	325mm
Internal Drawer Height:	122mm
Internal Drawer Width:	702mm
Drawer Cut Out (W&D):	142x248mm
Internal Depth Front to Back:	330mm
Internal Height Above Shelf:	100mm
Depth of Unit when Drawer/ Doors fully extended:	830mm
Height of Rear Void:	475mm

FAQs

Q: Are any components shared?	A: Hangers for column are new/Column glass shelf supports same as Vista/ WM unit hangers are the same as Vista, Cypher, Moment/ Runners are the same as used on Vista and Cypher
Q: Are the handles pre-fitted?	A: Yes and are glued in place so replacements need to be complete doors/drawer fronts.
Q: Are the shelves removable?	A: Yes, the shelves are removable.
Q: How big is the plumbing void	A: 50mm
Q: Are the runners soft close?	A: The runners are both soft close and quick release.
Q: What is the interior finish of the unit?	A: White for Alpine Elm & Gloss white, Grey for Charcoal Elm & Gloss Light Grey.

NOTE: Colours unique to Roper Rhodes - No RAL Code available